

navico

Autopilot Guide

March 2020



LOWRANCE

SIMRAD

B&G

MAP

Summary

- **Tiller Steered Boat** | Tiller Pilot
- **Sail Boat** | In-Board Pilot
- **Motor Boat** | Out-Board & Stern Drive
- **Motor Boat** | In-Board
- Autopilot components &  Compatibility

How To Read :



- Click on **Page Number** to reach a page



- Click on **Home Icon** to Go Back to Boat Model Page (Page 2)



Vessel Dimensions

Tiller Steered Boat | Tiller Pilot

Length	Displacement
< 29'	
< 33'	< 5 Tonnes
< 35'	< 5.7 Tonnes



Vessel Dimensions

Sail Boat | In-Board Pilot

Length	Displacement
25 to 33'	< 6 Tonnes
30 to 37'	< 8 Tonnes
35 to 43'	< 12 Tonnes
40 to 55'	< 20 Tonnes
> 55'	< 36 Tonnes
> 55'	< 55 Tonnes

Always remember to use the fully laden displacement of your boat when selecting a pilot. Typically a yacht fully provisioned with the water and fuel tanks full, can be as much as 20% above the designed displacement. If your boat falls between two pilot types, choose the larger pilot type - an under rated pilot may not be able to perform adequately when you need it most.



Vessel Specifications

Motor boat | Out-Board

Length	Steering System	RAM Capacity
< 10m	Cable	
< 10m	Hydraulic	< 220 cm ³
< 10m	Hydraulic	80 to 250 cm ³
> 10m	Hydraulic	160 to 550 cm ³
> 10m	Hydraulic	370 to 590 cm ³
> 10m	Hydraulic	370 to 960 cm ³
	Yamaha Helm Master	
	Seastar Optimus 360	





Vessel Specifications

Motor boat | In-Board

Length	Steering System	RAM Cylinder
< 10m	Hydraulic	80 to 250 cm ³
> 10m	Hydraulic	160 to 550 cm ³
> 10m	Hydraulic	370 to 590 cm ³
> 10m	Hydraulic	370 to 960 cm ³
	Volvo IPS	

Tiller Steered Boat | Tiller Pilot

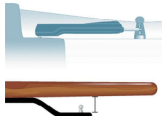
Auto Pilot System	
P/N	Item Name
TP10	Tiller Pilot - 65Kg

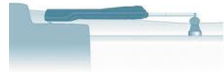
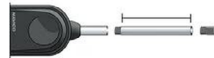
Accessories		
P/N	Item Name	
CB1	Cantilever bracket 135-240 mm	
TB30	Tiller Bracket 30mm	
TB60	Tiller Bracket 60mm	
TB90	Tiller Bracket 90mm	
TB120	Tiller Bracket 120mm	
PB30	Pedestal 30mm	
PB60	Pedestal 60mm	
PB90	Pedestal 90mm	
PRE30	Push Rod Extension 30mm	 
PRE60	Push Rod Extension 60mm	
PRE90	Push Rod Extension 90mm	
PRE120	Push Rod Extension 120mm	
PRE150	Push Rod Extension 150mm	
PRE300	Push Rod Extension 300mm	

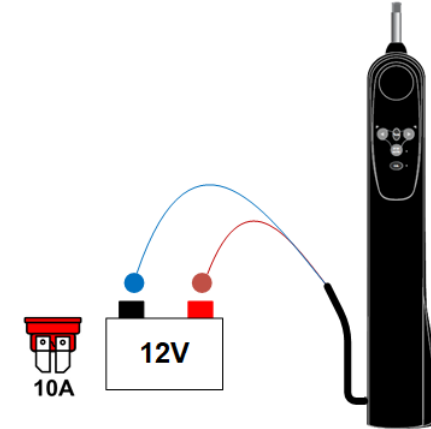
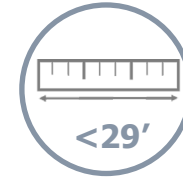

Tiller Steered Boat Tiller Pilot

Auto Pilot System	
P/N	Item Name
TP22	Tiller Pilot - 70Kg

Options	
P/N	Item Name
44172260	Mono Joiner Simnet
000-10760-001	Starter Kit NMEA2000
24006413	Micro-C female adaptor cable - 4m
000-13294-001	Triton ² Display
000-13296-001	Triton ² Pilot Keypad
Compatible with :	
000-12316-001	WR10 Autopilot remote and base station
Accessories	
Same as TP10	

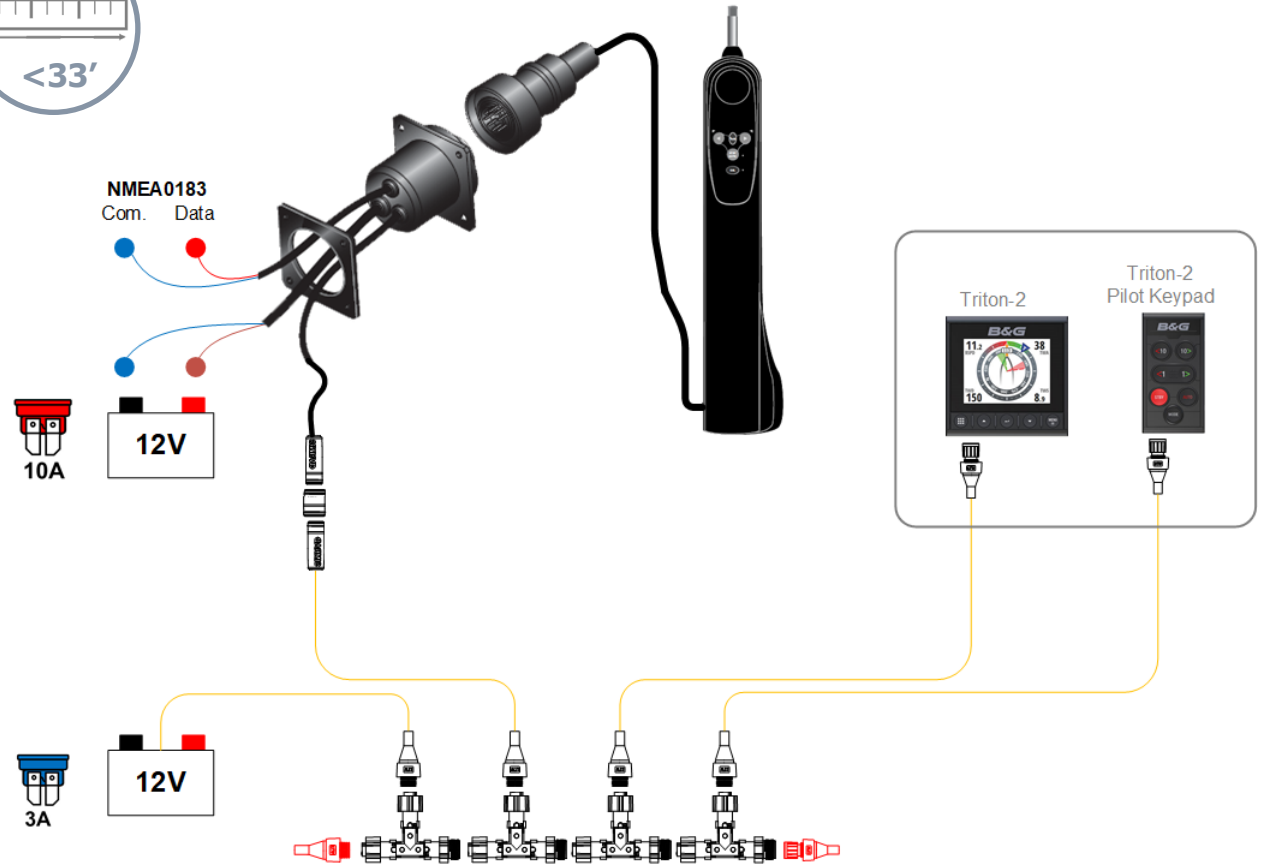
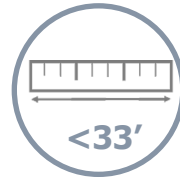

Tiller Steered Boat Tiller Pilot

Auto Pilot System	
P/N	Item Name
TP32	Tiller Pilot - 85Kg

Options	
P/N	Item Name
44172260	Mono Joiner Simnet
000-10760-001	Starter Kit NMEA2000
24006413	Micro-C female adaptor cable - 4m
000-13294-001	Triton ² Display
000-13296-001	Triton ² Pilot Keypad
Compatible with :	
000-12316-001	WR10 Autopilot remote and base station
Accessories	
Same as TP10	

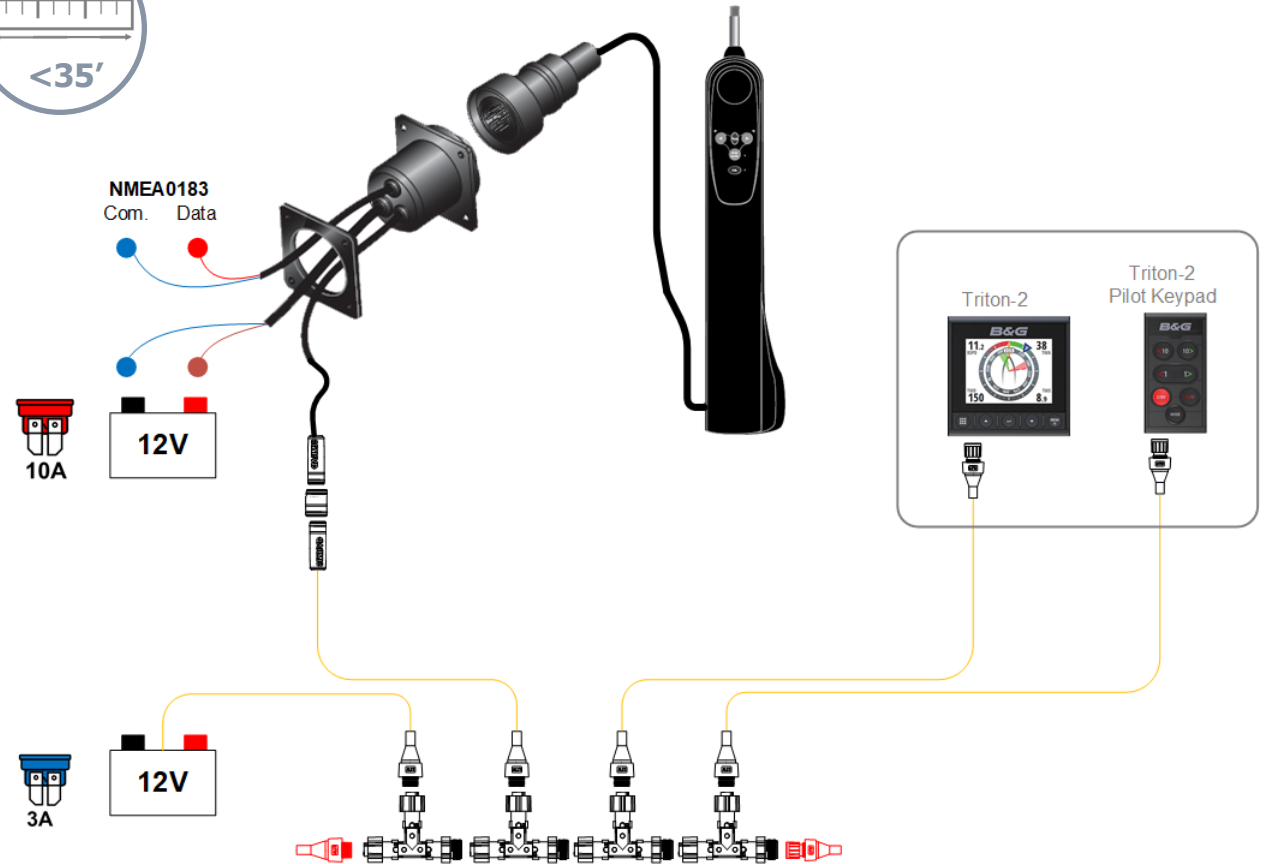
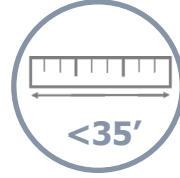

Sail Boat | In-Board Pilot

Auto Pilot System	
P/N	Item Name
000-13335-001	Nac-2 Core Pack
000-13561-001	Triton ² Pilot Keypad + Triton ² Display
Drive	
000-13902-001	Hydraulic RAM T0-12V
000-13697-001	SD10 Mechanical Drive unit - Built-in Rudder feedback

Options	
P/N	Item Name
22098552	DST800 Triducer
000-14382-001	Pack WS310 - 20m
Compatible with :	
000-12316-001	WR10 Autopilot remote and base station
Vulcan Series - All screen sizes with Triton ² Pilot Keypad	
Zeus Evo2/Evo3/Evo3S - All screen sizes	
Zeus GH Evo2/Evo3/Evo3S - All screen sizes	

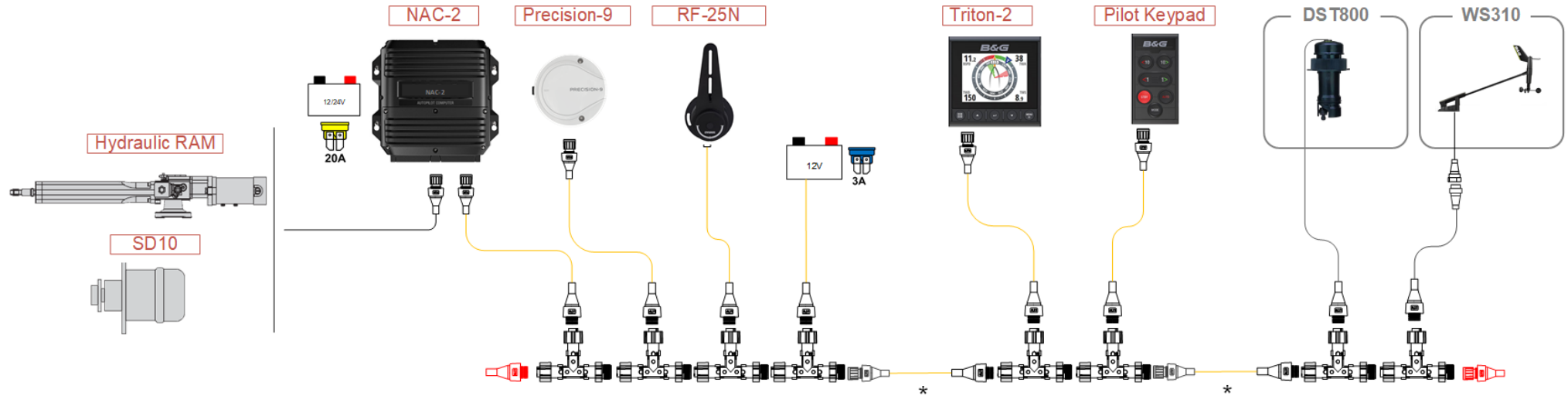
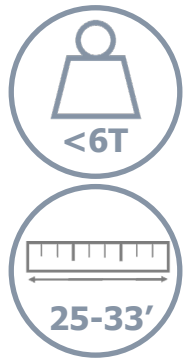

(*) Cables not included in the list. Lengths must be defined according to boat configuration

Sail Boat | In-Board Pilot

Auto Pilot System	
P/N	Item Name
000-13336-001	Nac-3 Core Pack
000-13561-001	Triton ² Pilot Keypad + Triton ² Display
Drive	
000-13902-001	Hydraulic RAM T0-12V
Drive	
21119896	DD15 Drive Unit - Rudder feedback RF300 included
44172096	Draglink 200-300mm
44172088	Draglink 300-400mm
44172104	Draglink 400-500mm

Options	
P/N	Item Name
22098552	DST800 Triducer
000-14382-001	Pack WS310 - 20m
Compatible with :	
000-12316-001	WR10 Autopilot remote and base station
Vulcan Series - All screen sizes with Triton ² Pilot Keypad	
Zeus Evo2/Evo3/Evo3S - All screen sizes	
Zeus GH Evo2/Evo3/Evo3S - All screen sizes	

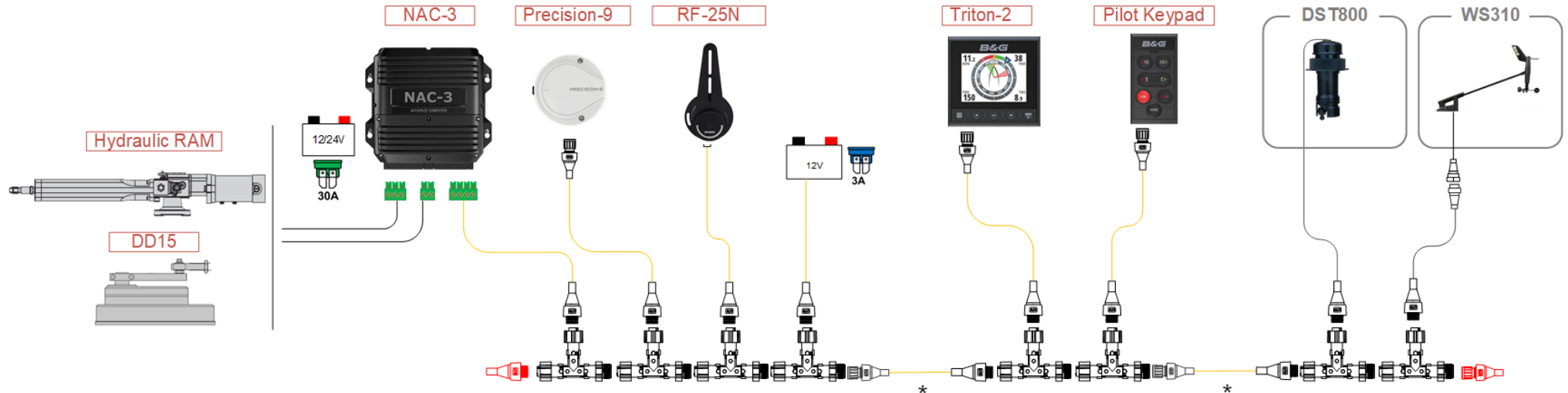
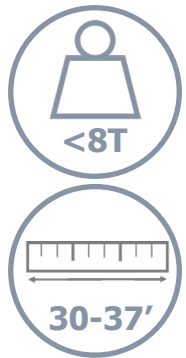

(*) Cables not included in the list. Lengths must be defined according to boat configuration

Sail Boat | In-Board Pilot

Auto Pilot System	
P/N	Item Name
000-13336-001	Nac-3 Core Pack
000-13561-001	Triton ² Pilot Keypad + Triton ² Display
Drive	
RAM-T1-12V	Hydraulic RAM T1-12V

Options	
P/N	Item Name
22098552	DST800 Triducer
000-14382-001	Pack WS310 - 20m
000-14843-001	Pack WS310 - 35m
Compatible with :	
000-12316-001	WR10 Autopilot remote and base station
Vulcan Series - All screen sizes with Triton ² Pilot Keypad	
Zeus Evo2/Evo3/Evo3S - All screen sizes	
Zeus GH Evo2/Evo3/Evo3S - All screen sizes	

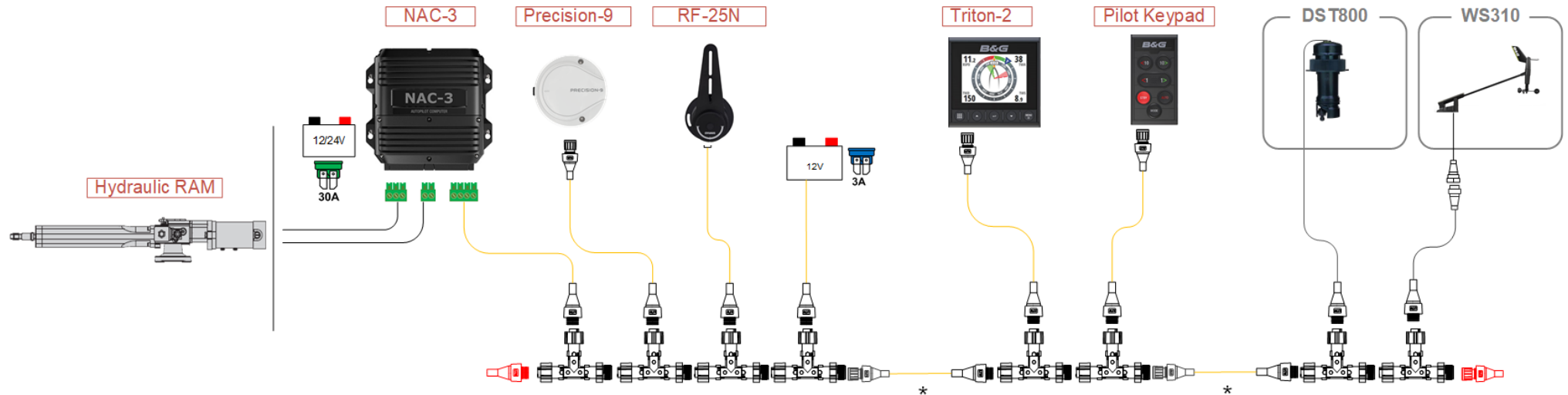
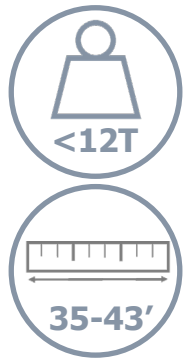

(*) Cables not included in the list. Lengths must be defined according to boat configuration

Sail Boat | In-Board Pilot

Auto Pilot System	
P/N	Item Name
000-13336-001	Nac-3 Core Pack
000-13561-001	Triton ² Pilot Keypad + Triton ² Display
Drive	
RAM-T2-12V	Hydraulic RAM T2-12V
RAM-T2-24V	Hydraulic RAM T2-24V

Options	
P/N	Item Name
22098552	DST800 Triducer
000-14382-001	Pack WS310 - 20m
000-14843-001	Pack WS310 - 35m
Compatible with :	
000-12316-001	WR10 Autopilot remote and base station
Vulcan Series - All screen sizes with Triton ² Pilot Keypad	
Zeus Evo2/Evo3/Evo3S - All screen sizes	
Zeus GH Evo2/Evo3/Evo3S - All screen sizes	

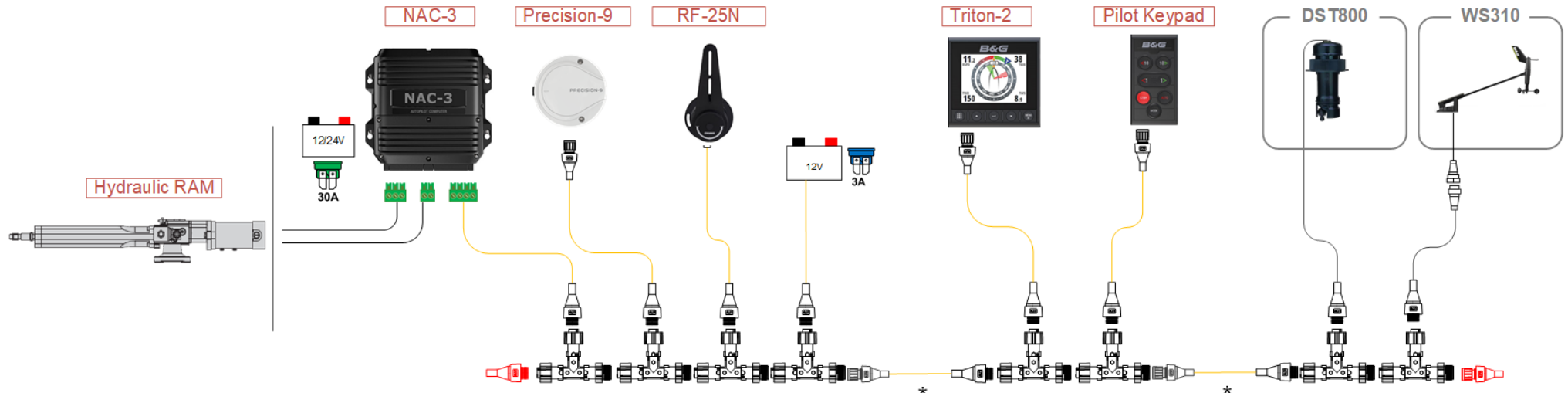
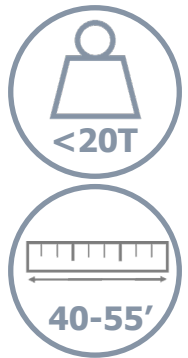

(*) Cables not included in the list. Lengths must be defined according to boat configuration

Sail Boat | In-Board Pilot

Auto Pilot System	
P/N	Item Name
000-13336-001	Nac-3 Core Pack
000-13561-001	Triton ² Pilot Keypad + Triton ² Display
Drive	
000-13788-001	Hydraulic RAM T3-12V
RAM-T3-24V	Hydraulic RAM T3-24V

Options	
P/N	Item Name
22098552	DST800 Triducer
000-14843-001	Pack WS310 - 35m
000-14391-001	Girouette WS310 sans câble
000-14398-001	Câble Girouette 50m
Compatible with :	
000-12316-001	WR10 Autopilot remote and base station
Vulcan Series - All screen sizes with Triton ² Pilot Keypad	
Zeus Evo2/Evo3/Evo3S - All screen sizes	
Zeus GH Evo2/Evo3/Evo3S - All screen sizes	

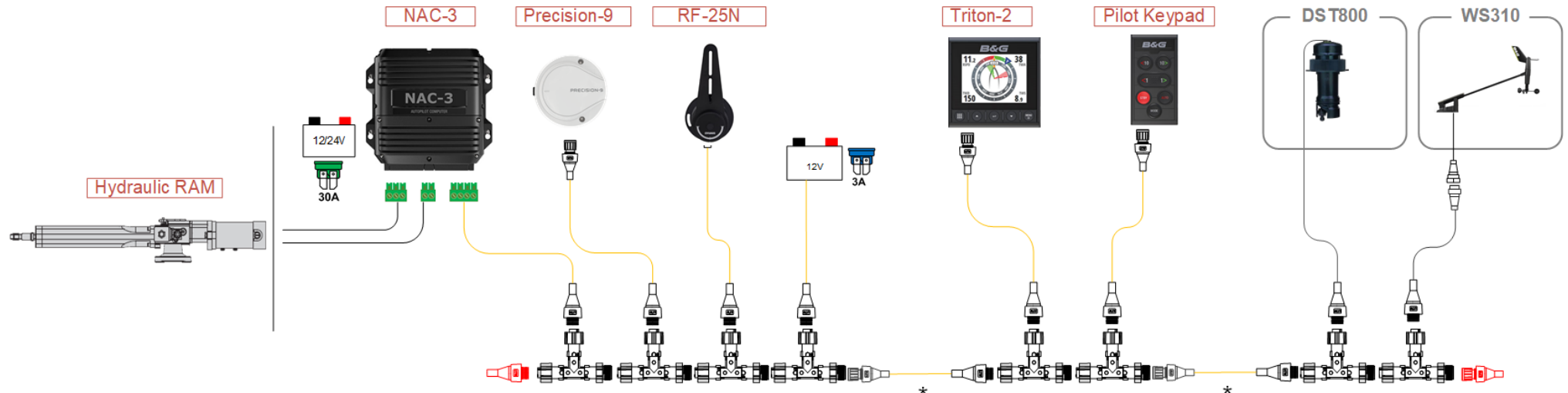
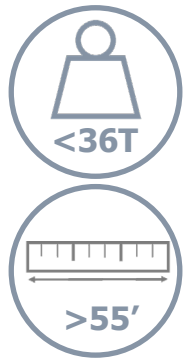

(*) Cables not included in the list. Lengths must be defined according to boat configuration

Sail Boat | In-Board Pilot

Auto Pilot System	
P/N	Item Name
000-13336-001	Nac-3 Core Pack
000-13561-001	Triton ² Pilot Keypad + Triton ² Display
Drive	
RAM-T4-24V	Hydraulic RAM T4-24V

Options	
P/N	Item Name
22098552	DST800 Triducer
000-14843-001	Pack WS310 - 35m
000-14391-001	Girouette WS310 sans câble
000-14398-001	Câble Girouette 50m
Compatible with :	
000-12316-001	WR10 Autopilot remote and base station
Vulcan Series - All screen sizes with Triton ² Pilot Keypad	
Zeus Evo2/Evo3/Evo3S - All screen sizes	
Zeus GH Evo2/Evo3/Evo3S - All screen sizes	

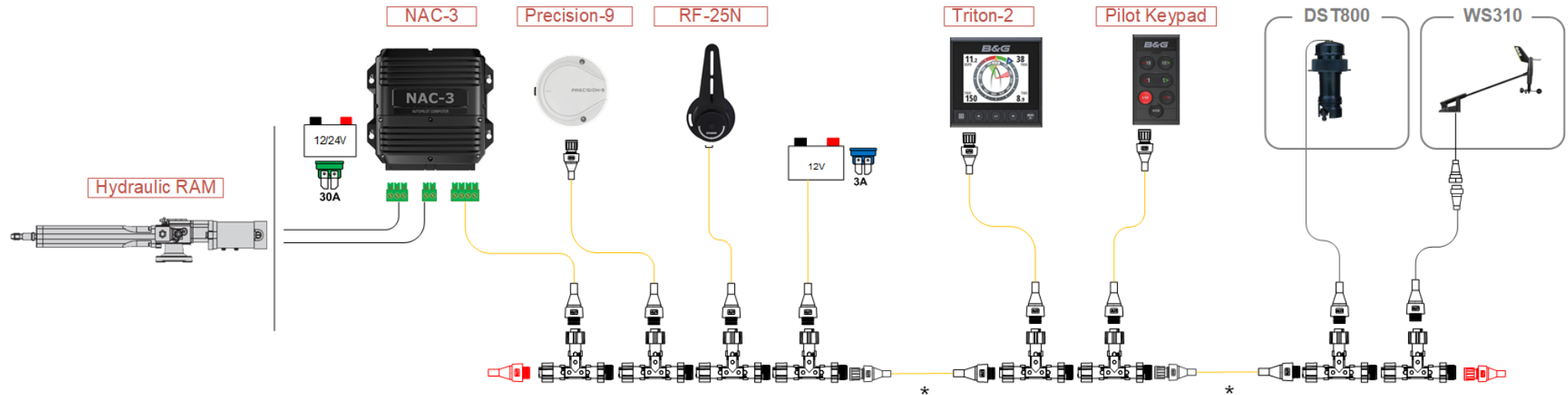
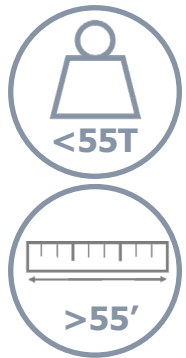

(*) Cables not included in the list. Lengths must be defined according to boat configuration

Motor Out-Board | Cable Drive

Auto Pilot System #1 - LOWRANCE	
P/N	Item Name
000-11749-001	Outboard Pilot Cable Steer Pack - Compatible with teleflex SSC52 - Morse 290,304411
000-14418-001	HDS-7 Live

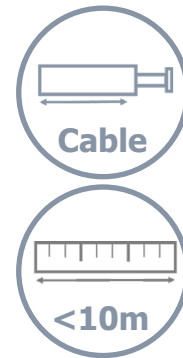
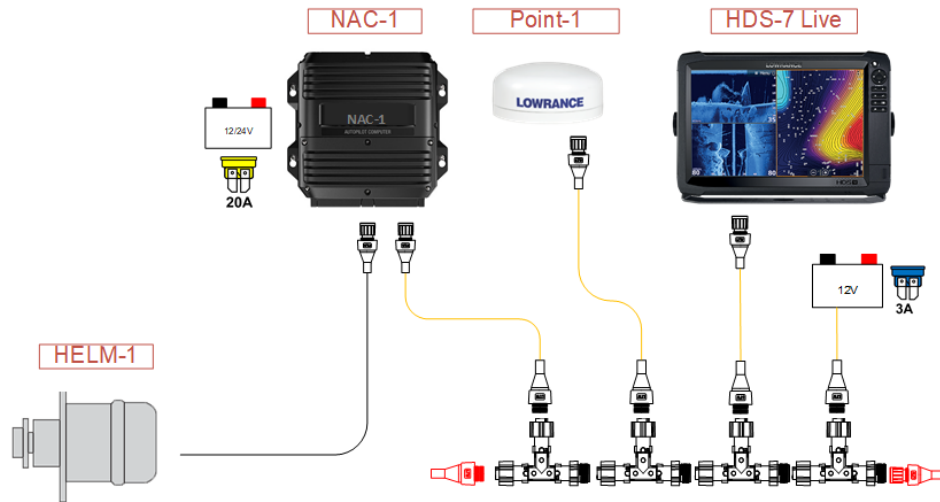

NAC-1 is not compatible with Simrad Pilot head

Auto Pilot System #2 - SIMRAD	
P/N	Item Name
000-13337-001	NAC-2 VRF Core Pack
000-11771-001	Helm-1 for NAC-1 & NAC-2
000-13289-001	AP-44 Autopilot Controller

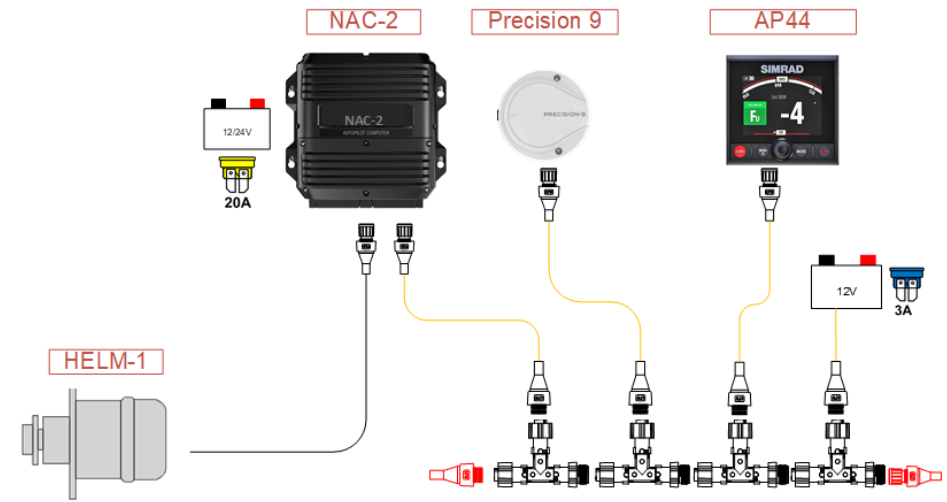

NAC-2 is not compatible with Lowrance Pilot head

Motor Out- Board | Hydraulic Drive

Auto Pilot System #1 - LOWRANCE	
P/N	Item Name
000-11749-001	Outboard Pilot Hydraulic Pack - Contains Pump-1 hydraulic fitting kit (000-12252-001)
000-14418-001	HDS-7 Live

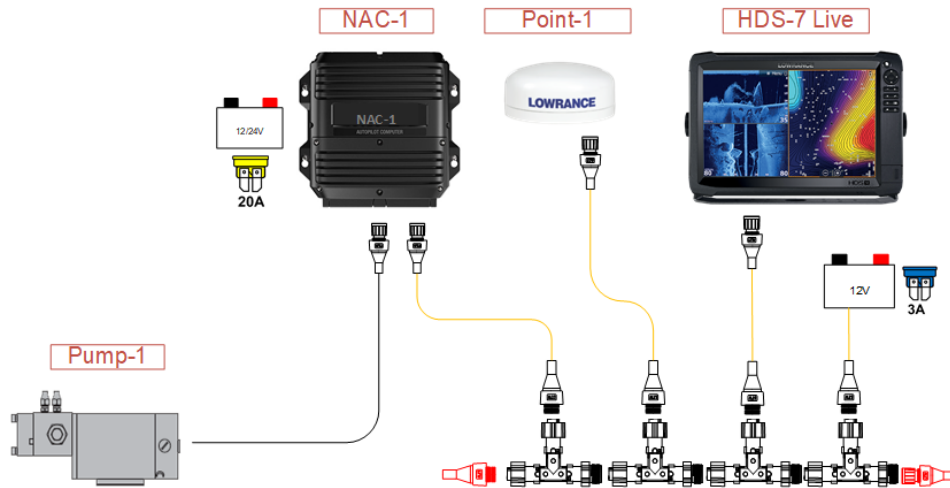

NAC-1 is not compatible with Simrad Pilot head

Auto Pilot System #2 - SIMRAD	
P/N	Item Name
000-13337-001	NAC-2 VRF Core Pack
000-11770-001	Pump-1 Hydraulic Pump
000-13289-001	AP-44 Autopilot Controller

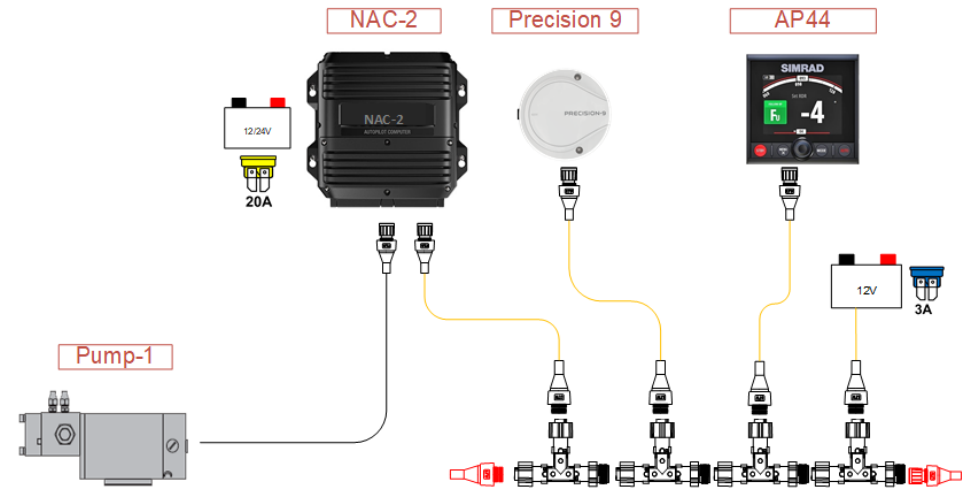

NAC-2 is not compatible with Lowrance Pilot head

Motor Out-Board | Hydraulic Drive

Auto Pilot System	
P/N	Item Name
000-13337-001	NAC-2 VRF Core Pack
000-13289-001	AP-44 Autopilot Controller
Drive	
000-13765-001	RPU80 All region

Compatible with :	
P/N	Item Name
000-12316-001	WR10 Autopilot remote and base station
000-13287-001	OP-12 Autopilot Controller
000-13894-001	AP-48 Rotary Autopilot Controller
000-10185-001	NF-80 Remote control
000-10183-001	FU-80 Remote control
000-10184-001	QS-80 Remote control
NSS Evo2/Evo3/Evo3S - All screen sizes	
NSO Evo2/Evo3/Evo3S - All screen sizes	

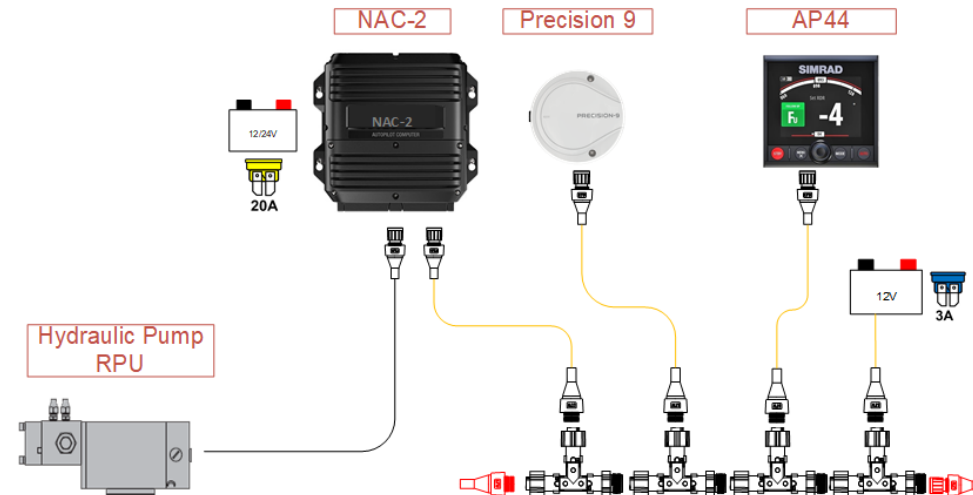
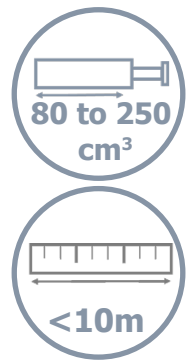

Motor Out-Board | Hydraulic Drive

Auto Pilot System	
P/N	Item Name
000-13338-001	NAC-3 VRF Core Pack
000-13289-001	AP-44 Autopilot Controller
20188074	Linear Rudder Feedback LF3000
20188082	Linear Feedback Interface LFI3000 MK2
Drive	
000-13766-001	RPU160 All region

Compatible with :	
P/N	Item Name
000-12316-001	WR10 Autopilot remote and base station
000-13287-001	OP-12 Autopilot Controller
000-13894-001	AP-48 Rotary Autopilot Controller
000-10185-001	NF-80 Remote control
000-10183-001	FU-80 Remote control
000-10184-001	QS-80 Remote control
NSS Evo2/Evo3/Evo3S - All screen sizes	
NSO Evo2/Evo3/Evo3S - All screen sizes	

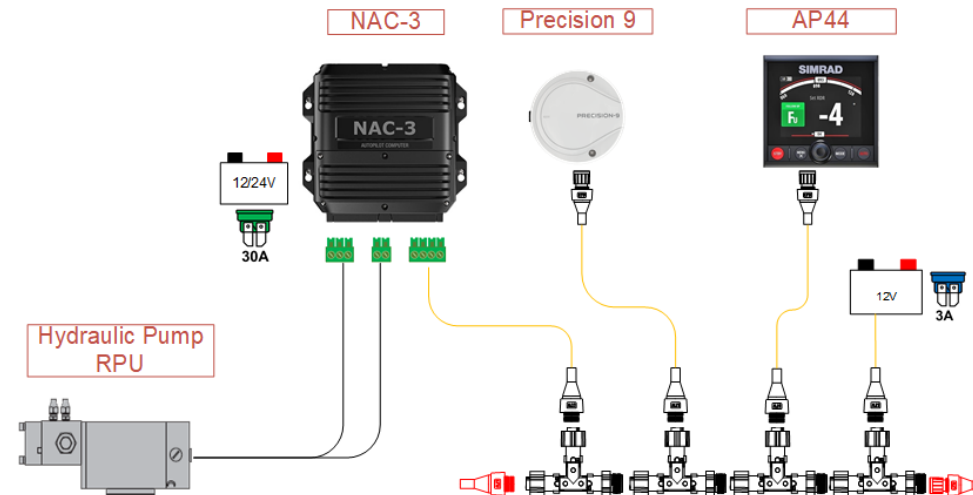
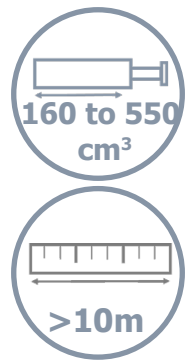

Motor Out-Board | Hydraulic Drive

Auto Pilot System	
P/N	Item Name
000-13338-001	NAC-3 VRF Core Pack
000-13289-001	AP-44 Autopilot Controller
20188074	Linear Rudder Feedback LF3000
20188082	Linear Feedback Interface LFI3000 MK2
Drive	
000-13767-001	RPU300 12V All region

Compatible with :	
P/N	Item Name
000-12316-001	WR10 Autopilot remote and base station
000-13287-001	OP-12 Autopilot Controller
000-13894-001	AP-48 Rotary Autopilot Controller
000-10185-001	NF-80 Remote control
000-10183-001	FU-80 Remote control
000-10184-001	QS-80 Remote control
NSS Evo2/Evo3/Evo3S - All screen sizes	
NSO Evo2/Evo3/Evo3S - All screen sizes	

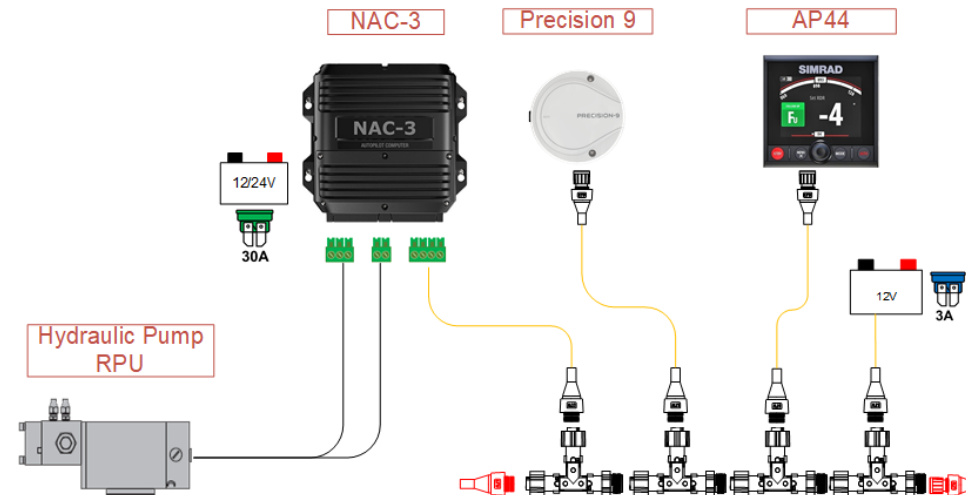
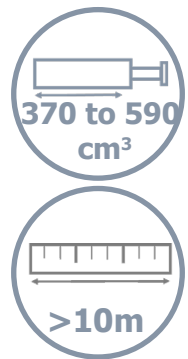

Motor Out-Board | Hydraulic Drive

Auto Pilot System	
P/N	Item Name
000-13338-001	NAC-3 VRF Core Pack
000-13289-001	AP-44 Autopilot Controller
20188074	Linear Rudder Feedback LF3000
20188082	Linear Feedback Interface LFI3000 MK2
Drive	
000-13768-001	RPU300 24V All region

Compatible with :	
P/N	Item Name
000-12316-001	WR10 Autopilot remote and base station
000-13287-001	OP-12 Autopilot Controller
000-13894-001	AP-48 Rotary Autopilot Controller
000-10185-001	NF-80 Remote control
000-10183-001	FU-80 Remote control
000-10184-001	QS-80 Remote control
NSS Evo2/Evo3/Evo3S - All screen sizes	
NSO Evo2/Evo3/Evo3S - All screen sizes	

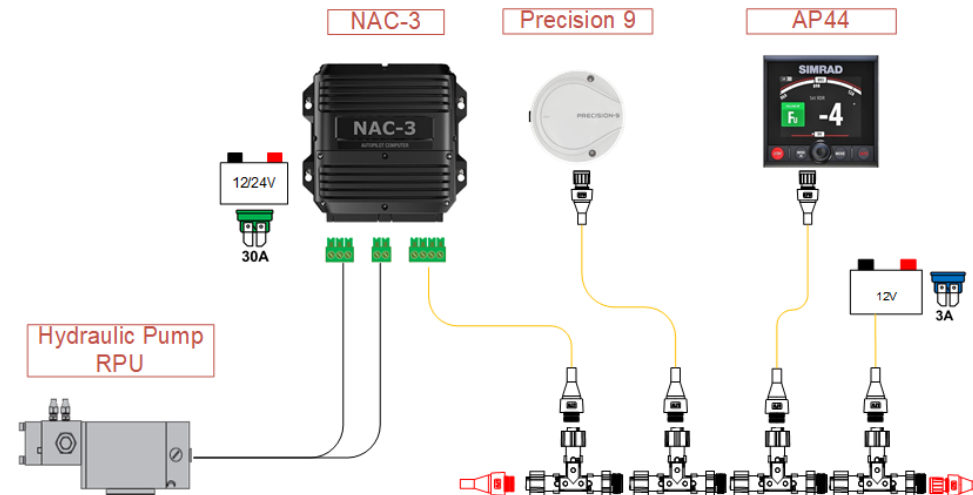
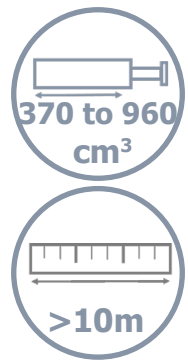

Motor Out-Board | Yamaha Helm Master

Auto Pilot System	
P/N	Item Name
000-11286-001	Yamaha Helm Master Autopilot Kit
000-13289-001	AP-44 Autopilot Controller
000-10760-001	Starter Kit NMEA2000

Compatible with :	
P/N	Item Name
000-12316-001	WR10 Autopilot remote and base station
000-13287-001	OP-12 Autopilot Controller
000-13894-001	AP-48 Rotary Autopilot Controller
000-10185-001	NF-80 Remote control
000-10183-001	FU-80 Remote control
000-10184-001	QS-80 Remote control
NSS Evo2/Evo3/Evo3S - All screen sizes	
NSO Evo2/Evo3/Evo3S - All screen sizes	

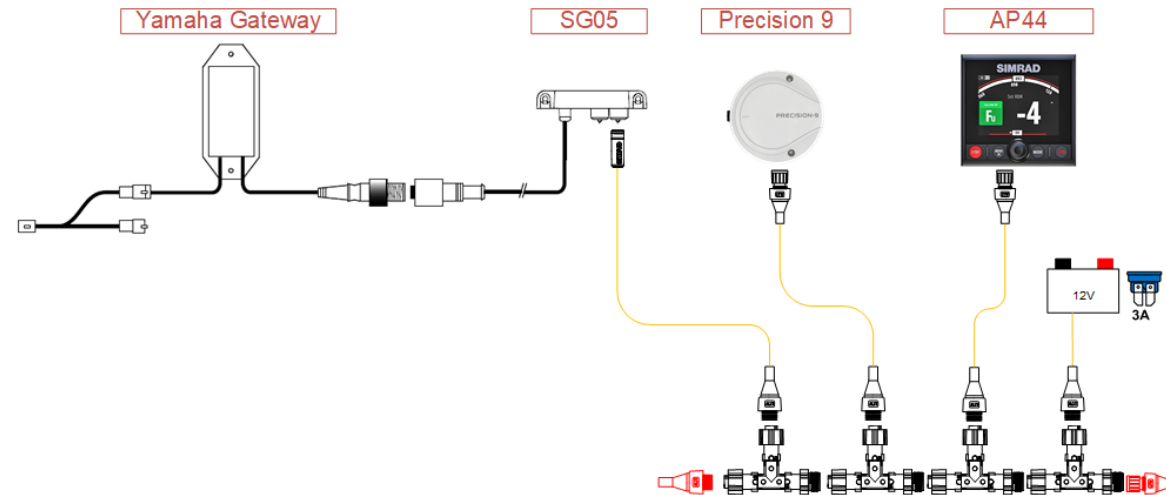

Motor Out-Board | Seastar Optimus 360

Auto Pilot System	
P/N	Item Name
000-10906-001	SG05 Autopilot for Optimus/Canbus Steer
24006413	Micro-C female adaptor cable - 4m
000-12607-001	Precision-9 Compass
000-13237-001	NSS7 Evo3
000-10760-001	Starter Kit NMEA2000

Compatible with :	
P/N	Item Name
000-10185-001	NF-80 Remote control
000-10183-001	FU-80 Remote control
000-10184-001	QS-80 Remote control
NSS Evo2/Evo3/Evo3S - All screen sizes	
NSO Evo2/Evo3/Evo3S - All screen sizes	

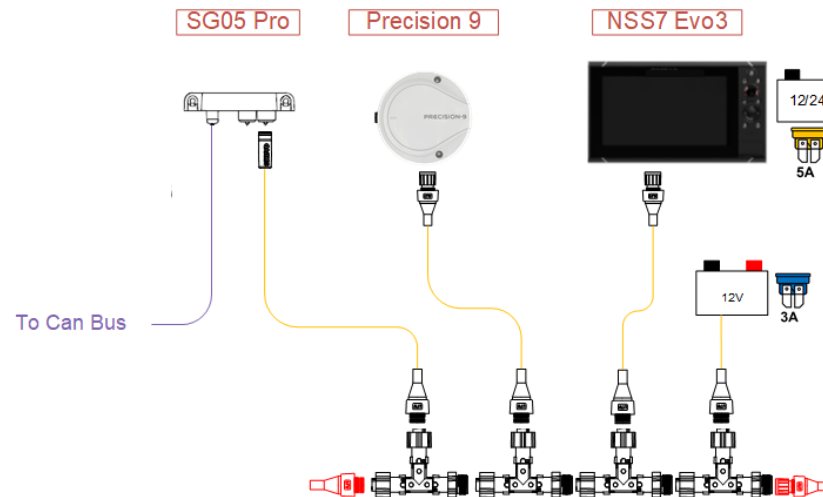

Motor In-Board | Hydraulic Drive

Auto Pilot System	
P/N	Item Name
000-13335-001	NAC-2 Core Pack
000-13289-001	AP-44 Autopilot Controller
Drive	
000-13765-001	RPU80 All region

Compatible with :	
P/N	Item Name
000-12316-001	WR10 Autopilot remote and base station
000-13287-001	OP-12 Autopilot Controller
000-13894-001	AP-48 Rotary Autopilot Controller
000-10185-001	NF-80 Remote control
000-10183-001	FU-80 Remote control
000-10184-001	QS-80 Remote control
NSS Evo2/Evo3/Evo3S - All screen sizes	
NSO Evo2/Evo3/Evo3S - All screen sizes	

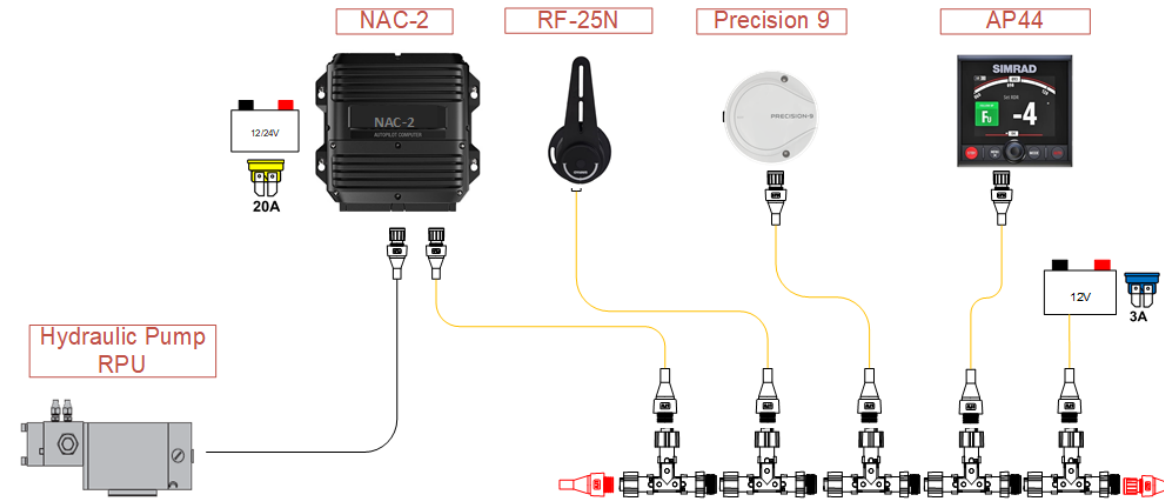
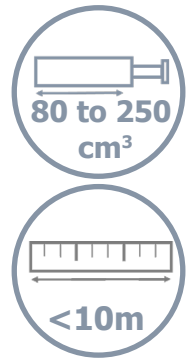

Motor In-Board | Hydraulic Drive

Auto Pilot System	
P/N	Item Name
000-13336-001	NAC-3 Core Pack
000-13289-001	AP-44 Autopilot Controller
Drive	
000-13766-001	RPU160 All region

Compatible with :	
P/N	Item Name
000-12316-001	WR10 Autopilot remote and base station
000-13287-001	OP-12 Autopilot Controller
000-13894-001	AP-48 Rotary Autopilot Controller
000-10185-001	NF-80 Remote control
000-10183-001	FU-80 Remote control
000-10184-001	QS-80 Remote control
NSS Evo2/Evo3/Evo3S - All screen sizes	
NSO Evo2/Evo3/Evo3S - All screen sizes	

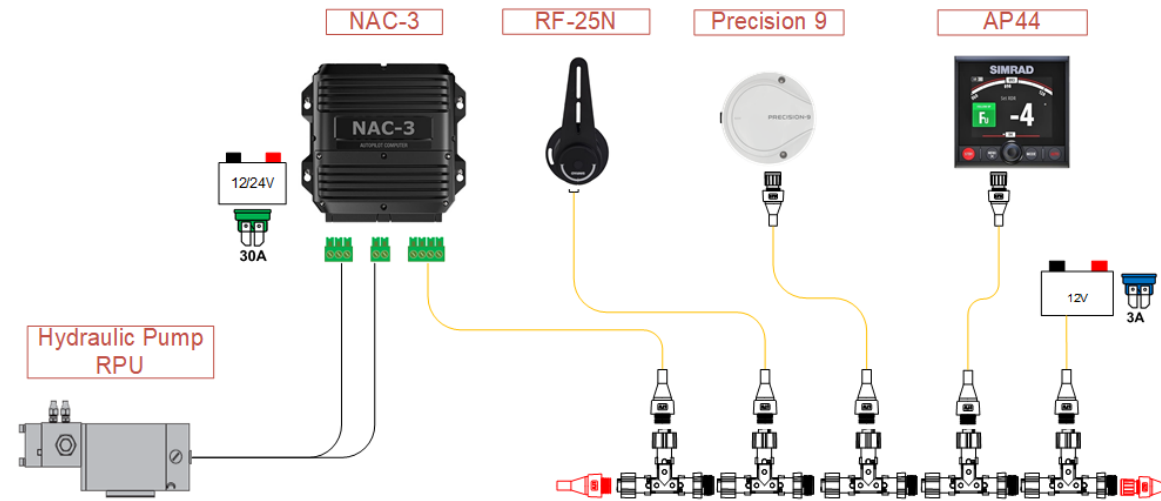
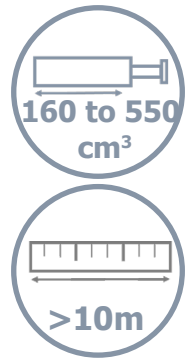

Motor In-Board | Hydraulic Drive

Auto Pilot System	
P/N	Item Name
000-13336-001	NAC-3 Core Pack
000-13289-001	AP-44 Autopilot Controller
Drive	
000-13767-001	RPU300 12V All region

Compatible with :	
P/N	Item Name
000-12316-001	WR10 Autopilot remote and base station
000-13287-001	OP-12 Autopilot Controller
000-13894-001	AP-48 Rotary Autopilot Controller
000-10185-001	NF-80 Remote control
000-10183-001	FU-80 Remote control
000-10184-001	QS-80 Remote control
NSS Evo2/Evo3/Evo3S - All screen sizes	
NSO Evo2/Evo3/Evo3S - All screen sizes	

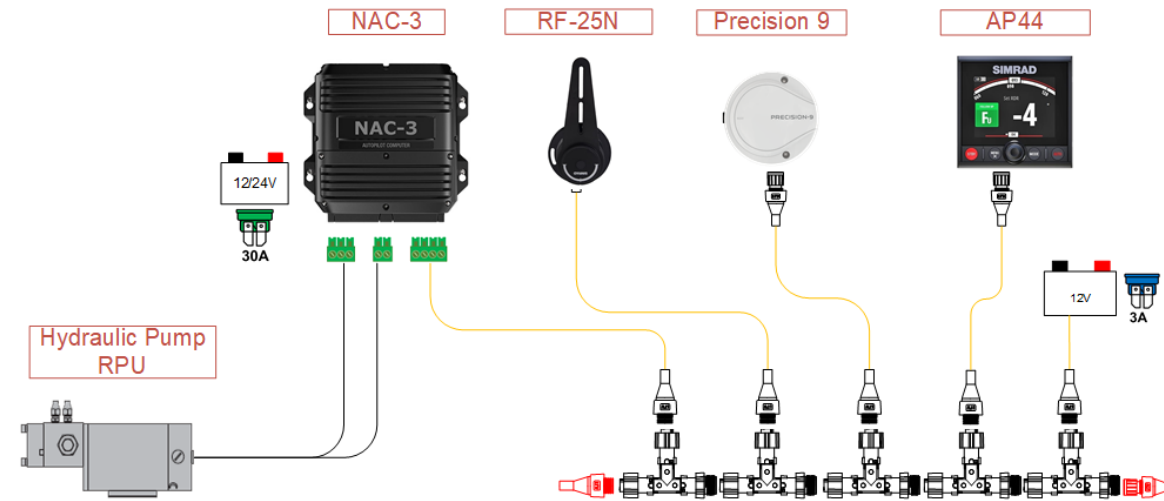
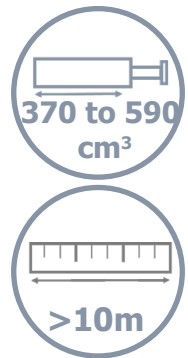

Motor In-Board | Hydraulic Drive

Auto Pilot System	
P/N	Item Name
000-13336-001	NAC-3 Core Pack
000-13289-001	AP-44 Autopilot Controller
Drive	
000-13768-001	RPU300 24V All region

Compatible with :	
P/N	Item Name
000-12316-001	WR10 Autopilot remote and base station
000-13287-001	OP-12 Autopilot Controller
000-13894-001	AP-48 Rotary Autopilot Controller
000-10185-001	NF-80 Remote control
000-10183-001	FU-80 Remote control
000-10184-001	QS-80 Remote control
NSS Evo2/Evo3/Evo3S - All screen sizes	
NSO Evo2/Evo3/Evo3S - All screen sizes	

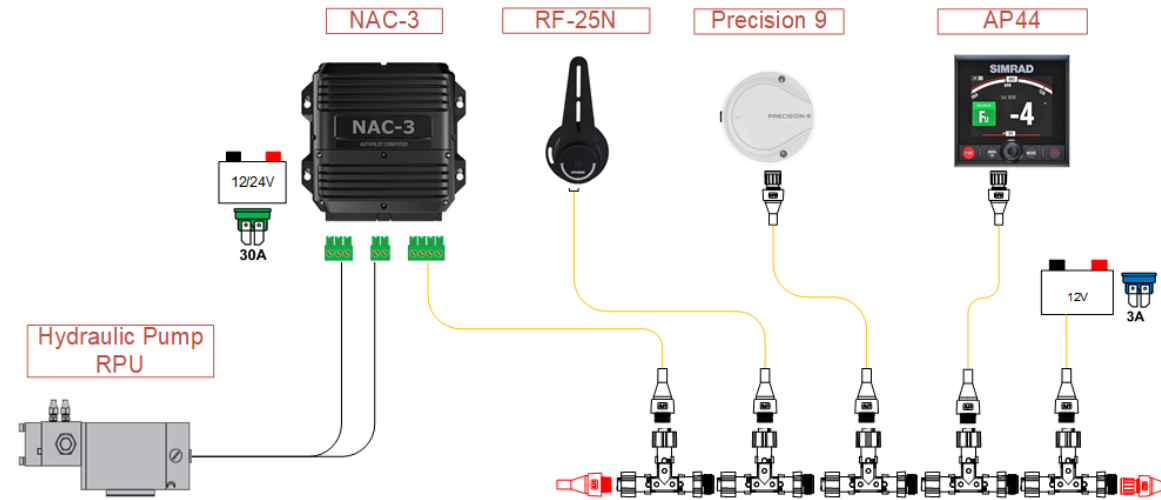
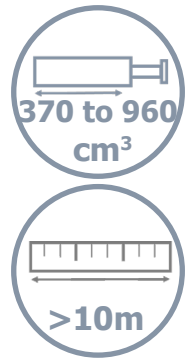

Motor In-Board | Volvo IPS

Auto Pilot System	
P/N	Item Name
000-10462-001	EVC Kit for IPS
000-13289-001	AP-44 Autopilot Controller
000-10760-001	Starter Kit NMEA2000

Compatible with :	
P/N	Item Name
000-12316-001	WR10 Autopilot remote and base station
000-13287-001	OP-12 Autopilot Controller
000-13894-001	AP-48 Rotary Autopilot Controller
000-10185-001	NF-80 Remote control
000-10183-001	FU-80 Remote control
000-10184-001	QS-80 Remote control
NSS Evo2/Evo3/Evo3S - All screen sizes	
NSO Evo2/Evo3/Evo3S - All screen sizes	

**VOLVO
PENTA**

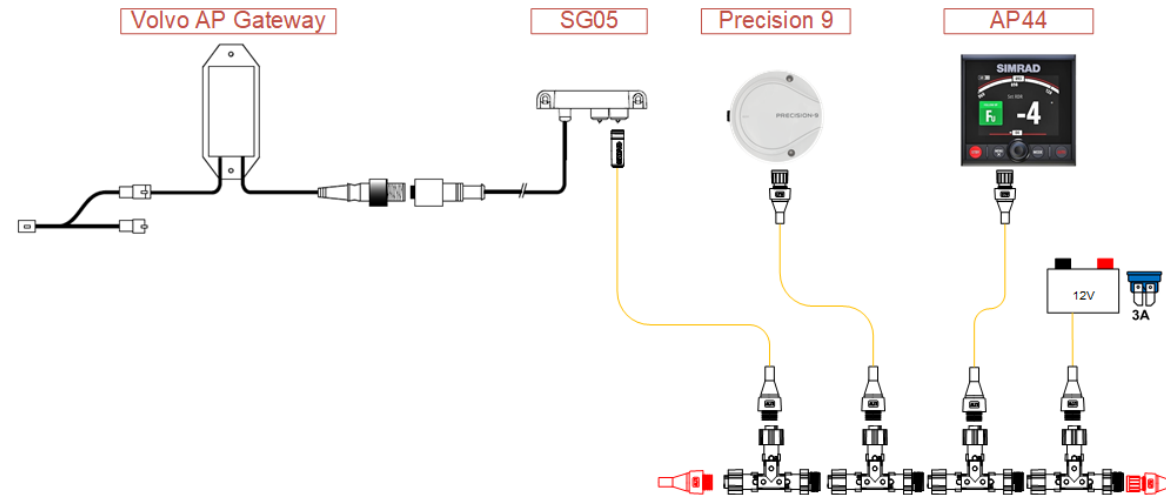

Autopilot Components

- **Computers**
- **Compasses**
- **Rudder feedback**

- **Compatibility tables**

System Builder

Visit Navico System Builder for products details and prices :

<https://systembuilder.navico.com>

Autopilot Components | Computers

Autopilot Computers											
Specifications			Inputs/Outputs					Autopilot Modes			
	Power	Performances	Solenoid Output	Clutch Output	Remote control Output	NMEA2000	NMEA0183	Auto Mode	Wind Mode	Turn Pattern	Depth Contour
NAC-1	9-16V	8A Cont - 12A Peak 1 Sec	✗	✗	Std By Button	✓	✗	✓	✗	✓	✓
NAC-2	9-31.2V	8A Cont - 12A Peak 1 Sec	✓	✓	Std By Button	✓	✗	✓	✓	✓	✓
NAC-3	9-31.2V	30A Cont - 50A Peak 1 Sec	✓	✓	✓	✓	✓	✓	✓	✓	✓
H5000	9-31.2V	30A Cont - 50A Peak 1 Sec	✓	✓	✓	✓	✗	✓	✓	✓	✓

Autopilot Computers																		
Rudder Feedback							Recommended Drives											
	RF40	RF25N	RF300	RF45X	LF3000	VRF	T0	T1	T2	T3	T4	Pump1	RPU80	RPU160	RPU300	DD15	Helm1	SD10
NAC-1	✓	✓	✗	✗	✗	✓	✗	✗	✗	✗	✗	✓	✗	✗	✗	✗	✓	✗
NAC-2	✓	✓	✗	✗	✗	✓	✓	✗	✗	✗	✗	✓	✓	✗	✗	✗	✓	✓
NAC-3	✗	✓	✓	✓	✓	✓	✓	✓	✓	✓	✓	✗	✓	✓	✓	✓	✗	✗
H5000	✗	✓	✓	✓	✗	✗	✓	✓	✓	✓	✓	✗	✗	✗	✗	✓	✗	✗



NAC-1



NAC-2



NAC-3



H5000 Autopilot Computer

Autopilot Components | Compasses

	Compasses										
	Outputs								GNSS		
	NMEA0183	NMEA2000	Heading	Rate Of Turn	Pitch/Roll	Heave	COG/SOG	Position	GPS	GLONASS	GALILEO
Point-1	X	✓	Magnetic	X	X	X	✓	✓	✓	✓	X
Precision-9	X	✓	Magnetic	✓	✓	✓	X	X	X	X	X
HS-60	X	✓	GNSS	✓	X	X	✓	✓	✓	✓	X
HS-75	X	✓	GNSS	✓	X	X	✓	✓	✓	✓	✓



Point-1



Precision-9



HS-60



HS-75

Autopilot Components | Rudder Feedback

Rudder Feedback							
Specifications				Autopilot Computer compatibility			
	Output	Connector	Cable length	NAC-1	NAC-2	NAC-3	H5000
RF40	Resistive	Specific for NAC-1/NAC-2	15m	✓	✓	✗	✗
RF25N	NMEA2000	Micro C	4m	✓	✓	✓	✓
RF300	Frequency	Bare wires	10m	✗	✗	✓	✓
RF45X	Frequency	Bare wires	10m	✗	✗	✓	✓
LF3000	Frequency signal from LFI3000 MK2	Bare wires	10m	✗	✗	✓	✗



RF-40



RF-25N



RF300



RF45X



LF3000

Autopilot Computer | Simrad Compatibility table

		SIMRAD																		
		Pilot Head									Remote			MFD's						
Pilot Computers		AP24	AP28	WR20	AP60	AP70	AP80	AP 44	AP48	A2004	OP10	OP12	QS80, FU80, NFU80	NSE	NSS	NSO	NSS evo2-evo3	NSO evo2-evo3	GO	
	AC12	✓	✓	✓	✗	✗	✗	✓	✓	✗	✓	✓	✓	✓	✓	✓	✓	✓	✓	✓*
	AC42	✓	✓	✓	✗	✗	✗	✓	✓	✗	✓	✓	✓	✓	✓	✓	✓	✓	✓	✓*
	NAC-1	✗	✗	✗	✗	✗	✗	✗	✗	✗	✗	✗	✗	✗	✗	✗	✗	✓	✓	✓*
	NAC-2	✗	✗	✗	✗	✗	✗	✓	✓	✗	✗	✓	✓	✗	✗	✗	✗	✓	✓	✓*
	NAC-3	✗	✗	✗	✗	✗	✗	✓	✓	✗	✗	✓	✓	✗	✗	✗	✗	✓	✓	✓*
	"MotorGuide Xi5 Trolling Motor"	✗	✗	✗	✗	✗	✗	✗	✗	✗	✗	✗	✗	✗	✗	✗	✗	✗	✗	✗
	AC70	✗	✗	✗	✓	✓	✓	✗	✗	✓	✗	✗	✓	✗	✗	✗	✗	Control Only	Control Only	✗
	AC80A, AC80S, AD80, SD80, AC85	✗	✗	✗	✗	✓	✓	✗	✗	✗	✗	✗	✓	✗	✗	✗	✗	Control Only	Control Only	✗
	SG05	✓	✓	✓	✗	✗	✗	✓	✓	✗	✗	✓	✓	✓	✓	✓	✓	✓	✓	✓*
	SG05 PRO	✗	✗	✗	✗	✓	✓	✗	✗	✗	✗	✗	✓	✗	✗	✗	✗	Control Only	Control Only	✗
H5000	✗	✗	✗	✗	✗	✗	✗	✗	✗	✗	✗	✗	✗	✗	✗	✗	✗	✗	✗	

* Requires OP12 for commissioning

Autopilot Computer | Lowrance Compatibility table

		Lowrance						
		MFD's						Remote
		HDS Gen2	HDS Gen2T	HDS Gen3	HDS Carbon	HDS Live	Elite/Hook	WR10
Pilot Computers	AC12	X	X	X	X	X	X	✓
	AC42	X	X	X	X	X	X	✓
	NAC-1	✓	✓	✓	✓	✓	X	✓
	NAC-2	X	X	X	X	X	X	✓
	NAC-3	X	X	X	X	X	X	✓
	"MotorGuide Xi5 Trolling Motor"	✓	✓	✓	✓	✓	X	X
	AC70	X	X	X	X	X	X	✓
	AC80A, AC80S, AD80, SD80, AC85	X	X	X	X	X	X	X
	SG05	X	X	X	X	X	X	✓
	SG05 PRO	X	X	X	X	X	X	X
	H5000	X	X	X	X	X	X	✓

Autopilot Computer | B&G Compatibility table

		B&G										Remote
		Pilot Head			MFD's							
Pilot Computers		Triton Controller	Triton ² Controller	H5000	Zeus	Zeus Touch	Zeus 2	Zeus2 Glass Helm	Zeus 3	Zeus3 Glass Helm	Vulcan	WR10
	AC12	✓	✓	✗	✓	✓	✓	✓	✓	✓	✓*	✓
	AC42	✓	✓	✗	✓	✓	✓	✓	✓	✓	✓*	✓
	NAC-1	✗	✗	✗	✗	✗	✗	✗	✗	✗	✗	✓
	NAC-2	✗	✓	✗	✗	✗	✓	✓	✓	✓	✓*	✓
	NAC-3	✗	✓	✗	✗	✗	✓	✓	✓	✓	✓*	✓
	"MotorGuide Xi5 Trolling Motor"	✗	✗	✗	✗	✗	✗	✗	✗	✗	✗	✗
	AC70	✗	✗	✗	✗	✗	✗	✗	✗	✗	✗	✓
	AC80A, AC80S, AD80, SD80, AC85	✗	✗	✗	✗	✗	✗	✗	✗	✗	✗	✗
	SG05	✗	✓	✗	✗	✗	✗	✗	✗	✗	✗	✓
	SG05 PRO	✗	✗	✗	✗	✗	✗	✗	✗	✗	✗	✗
H5000	✗	Control Only	✓	✗	✗	✓	✓	✓	✓	✓*	✓	

* Requires Triton² Controller for commissioning

