



DC THRUSTERS



BTQ

ELICHE DI MANOVRA DC DC THRUSTERS

ELICA SINGOLA / SINGLE PROPELLER

BTQ 110-25	12V	1,3 Kw	25 Kgf
BTQ 110-25 C	12V	1,3 Kw	25 Kgf
BTQ 125-30	12V	1,5 Kw	30 Kgf
BTQ 125-30 C	12V	1,5 Kw	30 Kgf
BTQ 125-40	12V	2,2 Kw	40 Kgf
BTQ 125-40 C	12V	2,2 Kw	40 Kgf
BTQ 140-30	12V	1,5 Kw	30 Kgf
BTQ 140-30 C	12V	1,5 Kw	30 Kgf
BTQ 140-40	12V	2,2 Kw	40 Kgf
BTQ 140-40 C	12V	2,2 Kw	40 Kgf
BTQ 185-55	12V / 24V	3 Kw	55 Kgf
BTQ 185-75	12V / 24V	4 Kw	75 Kgf
BTQ 185-95	12V / 24V	6 Kw	95 Kgf

ELICA DOPPIA / DOUBLE PROPELLER

BTQ 185-65	12V / 24V	3,3 Kw	65 Kgf
BTQ 185-65 C	12V / 24V	3,3 Kw	65 Kgf
BTQ 185-85	12V / 24V	4,3 Kw	85 Kgf
BTQ 185-85 C	12V / 24V	4,3 Kw	85 Kgf
BTQ 185-105	12V / 24V	6,3 Kw	105 Kgf
BTQ 250-120	12V / 24V	6,5 Kw	120 Kgf
BTQ 250-140	24 V	8 Kw	140 Kgf
BTQ 250-240	24 V	10 Kw	240 Kgf
BTQ 300-250	24 V	10 Kw	250 Kgf
BTQ 300-270	24 V	12 Kw	270 Kgf
BTQ 300-300	48 V	15 Kw	300 Kgf



DC THRUSTERS

BTQ TUNNEL 110 ELICA SINGOLA SINGLE PROPELLER



BTQ 110-25



BTQ 110-25 CB - IP66 Bow Thruster
BTQ 110-25 CS - IP66 Stern Thruster



KBTQ 110-25 12V
Modello disponibile in confezione kit.
Available model in kit packaging.

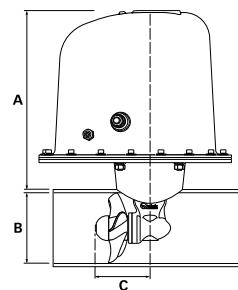
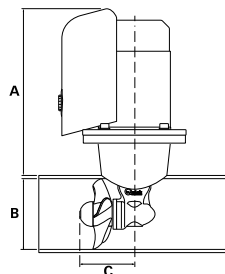

Bow Thruster CB

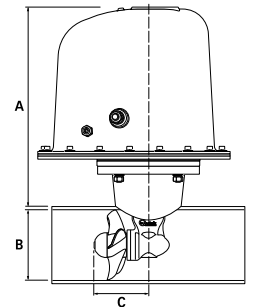

Stern Thruster CS

Modelli / Models		BTQ 110-25	BTQ 110-25 CB	BTQ 110-25 CS
Tipo Elica / Propulsion system		Elica singola / Single propeller		
Ø Tunnel		110 mm (4" 21/64 in)		
Voltaggio / Voltage		12 V	12 V	12 V
Potenza motore / Motor power		1,3 Kw		
Spinta / Thrust		25 Kgf (55.1 lb)		
Lunghezza imbarcazione* / Boat size*		5-7,5 m (16-25 ft)		
Peso / Weight		9,3 Kg (20.5 lb)	11,7 Kg (25.8 lb)	11,7 Kg (25.8 lb)
Dimensioni Dimensions	A	258 mm (10" 5/32 in)	282 mm (11" 7/64 in)	310 mm (12" 13/64 in)
	B	110 mm (4" 21/64 in)	110 mm (4" 21/64 in)	110 mm (4" 21/64 in)
	C	84 mm (3" 5/16 in in)	84 mm (3" 5/16 in in)	84 mm (3" 5/16 in in)

*Attenzione: l'indicazione può variare secondo il tipo di barca. / *Attention: the indication may vary according to the boat type.



DC THRUSTERS

BTQ TUNNEL 125 ELICA SINGOLA SINGLE PROPELLER



BTQ 125-30



BTQ 125-30 CB - IP66 Bow Thruster
BTQ 125-30 CS - IP66 Stern Thruster



BTQ 125-40



BTQ 125-40 CB - IP66 Bow Thruster
BTQ 125-40 CS - IP66 Stern Thruster



KBTQ 125-30 12V / KBTQ 125-40 12V
Modello disponibile in confezione kit.
Available model in kit packaging.

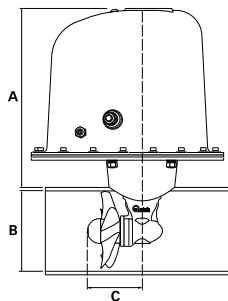
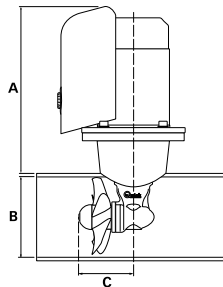

Bow Thruster CB

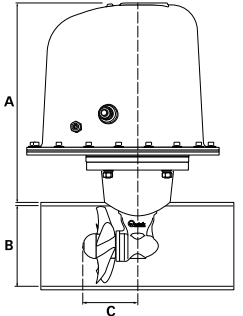

Stern Thruster CS

Modelli / Models		BTQ 125-30	BTQ 125-30 CB	BTQ 125-30 CS	BTQ 125-40	BTQ 125-40 CB	BTQ 125-40 CS
Tipo Elica / Propulsion system		Elica singola / Single propeller			Elica singola / Single propeller		
Ø Tunnel		125 mm (5" in)			125 mm (5" in)		
Voltaggio / Voltage		12 V	12 V	12 V	12V	12 V	12 V
Potenza motore / Motor power		1,5 Kw			2,2 Kw		
Spinta / Thrust		30 Kg _f (66 lb)			40 Kg _f (88.2 lb)		
Lunghezza imbarcazione* / Boat size*		6-8,5 m (20-28 ft)			7-9 m (23-29 ft)		
Peso / Weight		10 Kg (22 lb)	12,4 Kg (27.3 lb)	12,4 Kg (27.3 lb)	10,9 kg (24 lb)	13,3 kg (29.3 lb)	13,3 kg (29.3 lb)
Dimensioni Dimensions	A	258 mm (10" 5/32 in)	287 mm (11" 19/64 in)	315 mm (14" 9/64 in)	258 mm (10" 9/16 in)	287 mm (11" 19/64 in)	315 mm (14" 9/64 in)
	B	125 mm (4" in)	140 mm (5" 1/2 in)	140 mm (5" 1/2 in)	125 mm (5" 1/2 in)	140 mm (5" 1/2 in)	140 mm (5" 1/2 in)
	C	84 mm (3" 5/16 in in)	108 mm (4" 1/4 in in)	108 mm (4" 1/4 in in)	84 mm (4" 1/4 in in)	108 mm (4" 1/4 in in)	108 mm (4" 1/4 in in)

*Attenzione: l'indicazione può variare secondo il tipo di barca. / *Attention: the indication may vary according to the boat type.



DC THRUSTERS

BTQ TUNNEL 140 ELICA SINGOLA SINGLE PROPELLER



BTQ 140-30



BTQ 140-30 CB - IP66 Bow Thruster
BTQ 140-30 CS - IP66 Stern Thruster



BTQ 140-40



BTQ 140-40 CB - IP66 Bow Thruster
BTQ 140-40 CS - IP66 Stern Thruster



KBTQ 140-30 12V / KBTQ 140-40 12V
Modelli disponibile in confezione kit.
Available models in kit packaging.

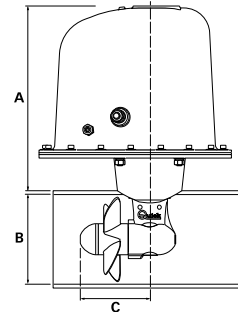
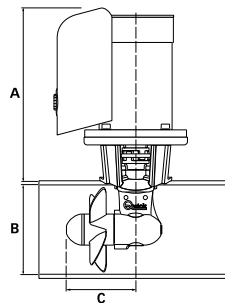

Bow Thruster CB

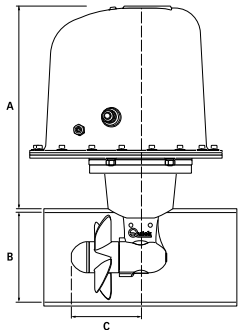

Stern Thruster CS

Modelli / Models		BTQ 140-30	BTQ 140-30 CB	BTQ 140-30 CS	BTQ 140-40	BTQ 140-40 CB	BTQ 140-40 CS
Tipo Elica / Propulsion system		Elica singola / Single propeller			Elica singola / Single propeller		
Ø Tunnel		140 mm (5" 1/2 in)			140 mm (5" 1/2 in)		
Voltaggio / Voltage		12 V	12 V	12 V	12V	12 V	12 V
Potenza motore / Motor power		1,5 Kw			2,2 Kw		
Spinta / Thrust		30 Kgf (66 lb)			40 Kgf (88.2 lb)		
Lunghezza imbarcazione* / Boat size*		7-8,5 m (23-28 ft)			7-9,5 m (23-31 ft)		
Peso / Weight		11,3 Kg (24.9 lb)	13,7 Kg (30.2 lb)	13,7 Kg (30.2 lb)	12,2 kg (26.9 lb)	14,6 kg (32.2 lb)	14,6 kg (32.2 lb)
Dimensioni Dimensions	A	268 mm (10" 9/16 in)	287 mm (11" 19/64 in)	315 mm (14" 9/64 in)	268 mm (10" 9/16 in)	287 mm (11" 19/64 in)	315 mm (14" 9/64 in)
	B	140 mm (5" 1/2 in)	140 mm (5" 1/2 in)	140 mm (5" 1/2 in)	140 mm (5" 1/2 in)	140 mm (5" 1/2 in)	140 mm (5" 1/2 in)
	C	108 mm (4" 1/4 in)	108 mm (4" 1/4 in)	108 mm (4" 1/4 in)	108 mm (4" 1/4 in)	108 mm (4" 1/4 in)	108 mm (4" 1/4 in)

*Attenzione: l'indicazione può variare secondo il tipo di barca. / *Attention: the indication may vary according to the boat type.



DC THRUSTERS

BTQ TUNNEL 185 ELICA SINGOLA SINGLE PROPELLER



BTQ 185-55

BTQ 185-75

BTQ 185-95



KBTQ 185-55 12/24V
Modello disponibile in confezione kit.
Available model in kit packaging.

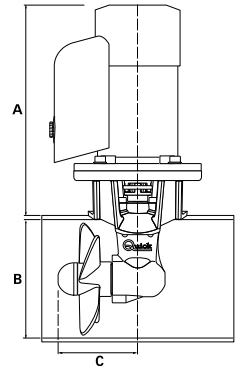

Modelli / Models	BTQ 185-55				BTQ 185-75				BTQ 185-95				
Tipo Elica / Propulsion system	Elica singola / Single propeller												
Ø Tunnel	185 mm		7" 9/32 in		185 mm		7" 9/32 in		185 mm		7" 9/32 in		
Voltaggio / Voltage	12 V / 24 V												
Potenza motore / Motor power	3 Kw				4 Kw				6 Kw				
Spinta / Thrust	55 Kgf		121,2 lb		75 Kgf		163,3 lb		95 Kgf		209,5 lb		
Lunghezza imbarcazione * / Boat size*	8-11 m		26-36 ft		10-13 m		33-43 ft		12-15 m		39-49 ft		
Peso / Weight	16,7 Kg	36,8 lb	16,9 Kg	37.2 lb	17,0 kg	37,5 lb	19,6 kg	43.2 lb	26,6 kg	58.6 lb	24,2 kg	53.3	
Dimensioni Dimensions	A	292 mm	11" 1/2 in	278 mm	10" 15/16 in	329 mm	12" in	280 mm	11" in	410 mm	16" 9/64 in	374 mm	14" 23/32 in
	B	185 mm	7" 9/32 in	185 mm	7" 9/32 in	185 mm	7" 9/32 in	185 mm	7" 9/32 in	185 mm	7" 9/32 in	185 mm	7" 9/32 in
	C	123 mm	4" 27/32 in	123 mm	4" 27/32 in	123 mm	4" 27/32 in	123 mm	4" 27/32 in	123 mm	4" 27/32 in	123 mm	4" 27/32 in

*Attenzione: l'indicazione può variare secondo il tipo di barca - *Attention: the indication may vary according to the boat type



DC THRUSTERS

BTQ TUNNEL 185

ELICA DOPPIA
DOUBLE PROPELLER



BTQ 185-65



BTQ 185-65 C IP66
Bow/Stern Thruster



BTQ 185-85



BTQ 185-85 C IP66
Bow/Stern Thruster



BTQ 185-105



KBQ 185-65 12/24V

Modello disponibile in confezione kit.
Available model in kit packaging.

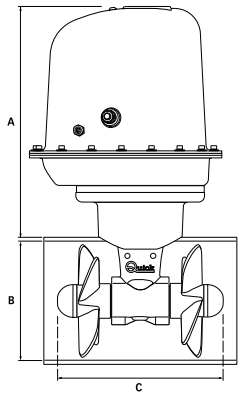
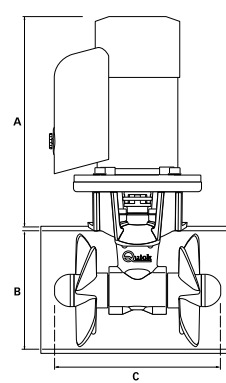
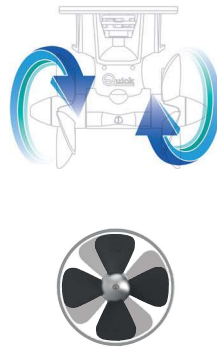

Bow/Stern Thruster

Modelli / Models		BTQ 185-65		BTQ 185-65 C		BTQ 185-85		BTQ 185-85 C		BTQ 185-105	
Tipo Elica / Propulsion system		Elica doppia / Double propeller									
Ø Tunnel		185 mm (7" 9/32 in)						185 mm (7" 9/32 in)		185 mm (7" 9/32 in)	
Voltaggio / Voltage		12 V	24 V	12 V	24 V	12V	24V	12V	24V	12 V	24 V
Potenza motore / Motor power		3,3 Kw				4,3 Kw				6,3 Kw	
Spinta / Thrust		65 Kg (143,3 lb)				85 Kg (187,4 lb)				105 Kg (231,5 lb)	
Lunghezza imbarcazione* / Boat size*		8-12 m (26-39 ft)				10-15 m (33-50 ft)				12-15 m (39-50 ft)	
Peso / Weight		17,6 kg (38.8 lb)	17,8 Kg (39.2 lb)	20,0 Kg (44.1 lb)	20,2 Kg (44.5 lb)	17,9 kg (39.4 lb)	20,5 kg (45.2 lb)	20,3 kg (44.7 lb)	22,9 kg (50.5 lb)	27,5 kg (60.6 lb)	25,1 Kg (55.3 lb)
Dimensioni Dimensions	A	292 mm (11" 1/2)	278 mm (10" 15/16)	359 mm (14" 9/64 in)		329 mm (12" in)	280 mm (11" in)	359 mm (14" 9/64 in)		410 mm (16" 9/64 in)	374 mm (14" 23/32 in)
	B	185 mm (7" 9/32 in)		185 mm (7" 9/32 in)		185 mm (7" 9/32 in)		185 mm (7" 9/32 in)		185 mm (7" 9/32 in)	
	C	265 mm (10" 7/16 in)		265 mm (10" 7/16 in)		265 mm (10" 7/16 in)		265 mm (10" 7/16 in)		265 mm (10" 7/16 in)	

*Attenzione: l'indicazione può variare secondo il tipo di barca - *Attention: the indication may vary according to the boat type



DC THRUSTERS

BTQ TUNNEL 250 ELICA DOPPIA DOUBLE PROPELLER



BTQ 250-120

BTQ 250-140

BTQ 250-240

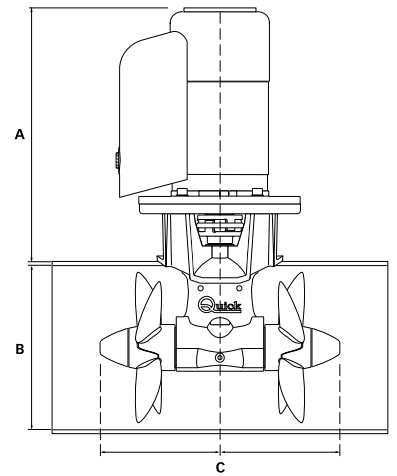
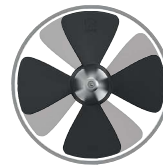
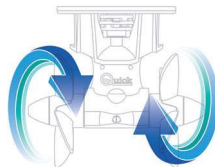

Modelli / Models	BTQ 250-120				BTQ 250-140		BTQ 250-240		
Tipo Elica / Propulsion system	Elica doppia / Double propeller				Elica doppia / Double propeller		Elica doppia / Double propeller		
Ø Tunnel	250 mm	9" 27/32 in	250 mm	9" 27/32 in	250 mm	9" 27/32 in	250 mm	9" 27/32 in	
Voltaggio / Voltage	12 V		24 V		24 V		24 V		
Potenza motore/ Motor power	6,5 Kw				8 Kw		10 Kw		
Spinta/Thrust	120 Kgf	264 lb	120 Kgf	264 lb	140 Kgf	308 lb	240 Kgf	529 lb	
Lunghezza imbarcazione* / Boat size*	13-17 m	42-55 ft	13-17 m	42-55 ft	14-18 m	45-59 ft	16-21 m	52-69 ft	
Peso / Weight	35,5 Kg	78.2 lb	34,2 Kg	75.4 lb	34,2 Kg	75.4 lb	49,1 Kg	108,2 lb	
Dimensioni Dimensions	A	390 mm	15" 11/32 in	390 mm	15" 11/32 in	394 mm	15" 1/2 in	471 mm	18" 1/2 in
	B	250 mm	9" 27/32 in	250 mm	9" 27/32 in	250 mm	9" 27/32 in	250 mm	9" 27/32 in
	C	373 mm	14" 11/16 in	373 mm	14" 11/16 in	373 mm	14" 11/16 in	373 mm	14" 11/16 in

*Attenzione: l'indicazione può variare secondo il tipo di barca - *Attention: the indication may vary according to the boat type



DC THRUSTERS

BTQ TUNNEL 300

ELICA DOPPIA
DOUBLE PROPELLER



BTQ 300-250



BTQ 300-270

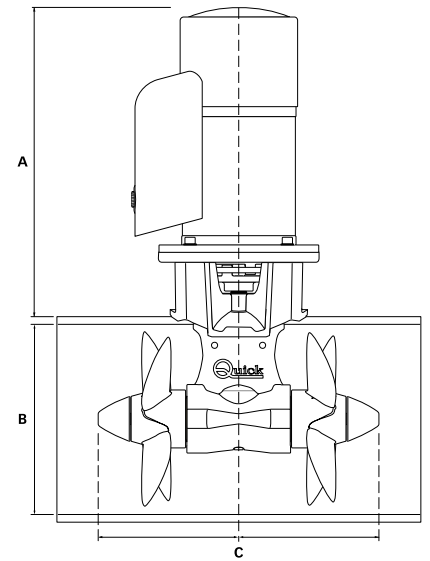
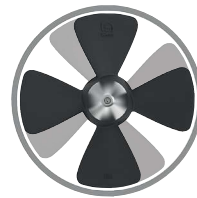

Modelli / Models		BTQ 300-250		BTQ 300-270	
Tipo Elica / Propulsion system		Elica doppia / Double propeller		Elica doppia / Double propeller	
Ø Tunnel		300 mm	11" 13/16 in	300 mm	11" 13/16 in
Voltaggio / Voltage		24 V		24 V	
Potenza motore/ Motor power		10 Kw		12 Kw	
Spinta/Thrust		250 Kgf	551 lb	270 Kgf	595 lb
Lunghezza imbarcazione* / Boat size*		20-26 m	65-85 ft	23-30 m	75-99 ft
Peso / Weight		46,7 Kg	102,9 lb	55,9 Kg	123,2 lb
Dimensioni Dimensions mm - inc	A	410 mm	16" 9/64 in	481 mm	18" 15/16 in
	B	300 mm	11" 13/16 in	300 mm	11" 13/16 in
	C	436 mm	17" 5/32 in	436 mm	17" 5/32 in

*Attenzione: l'indicazione può variare secondo il tipo di barca - *Attention: the indication may vary according to the boat type



DC THRUSTERS

BTQ TUNNEL 300 - 48V

ELICA DOPPIA (NIBRAL)
DOUBLE PROPELLER (NIBRAL)



BTQ 300-300

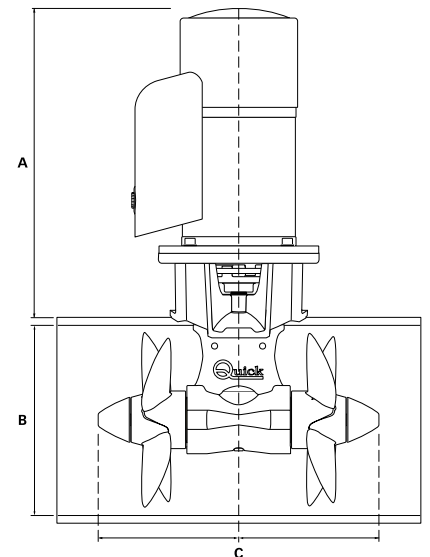
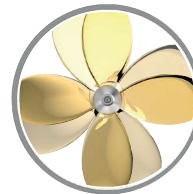
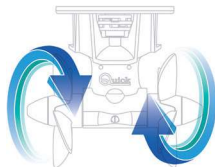

Modelli / Models		BTQ 300-300	
Tipo Elica / Propulsion system		Elica doppia (NIBRAL) / Double propeller (NIBRAL)	
Ø Tunnel		300 mm	11" 13/16 in
Voltaggio / Voltage		48 V	
Potenza motore/ Motor power		15 Kw	
Spinta/Thrust		300 Kgf	660 lb
Lunghezza imbarcazione* / Boat size*		20-28 m	66-92 ft
Peso / Weight		66,7 Kg	147 lb
Dimensioni Dimensions	A	520 mm	20" 15/32 in
	B	300 mm	11" 13/16 in
	C	434 mm	17" 1/16 in

*Attenzione: l'indicazione può variare secondo il tipo di barca - *Attention: the indication may vary according to the boat type

OPTIONAL



PSS PARALLEL-SERIAL SWITCH 24/48V

Questo dispositivo permette l'installazione di un propulsore con motore a 24 o 48 Vdc su imbarcazioni con impianto elettrico a 12 o 24 Vdc mediante l'uso di un gruppo batterie (12V o 24V) aggiuntivo.
This device allows the installation of a thruster with a 24 or 48 Vdc motor on boats with 12 or 24 Vdc electrical system through the use of a battery group (12V or 24V) added.